



Thule Rapid System Kit 1732

> Instructions

NISSAN Sentra, 4-dr Sedan, *13-

*North America

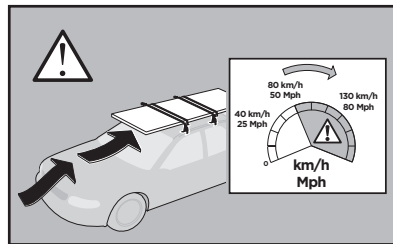
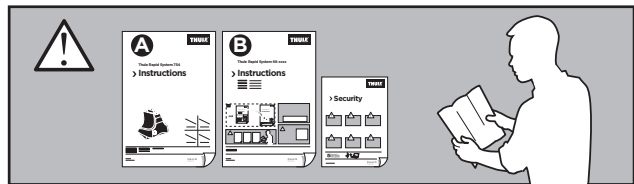
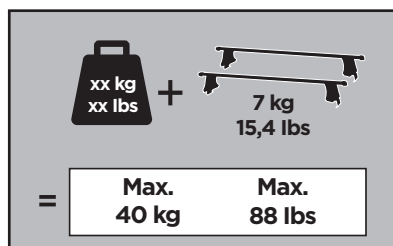

ISO 11154-E

141732

C.20130701
519-1732-01

Bring your life
thule.com



271 x2

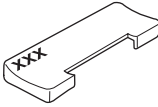

328 x2

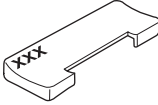

594 x2



1214 x2



x1



x1

1

	X (scale)	X (mm)	X (inch)
NISSAN Sentra, 4-dr Sedan, *13-	39,5	1046	41 1/8

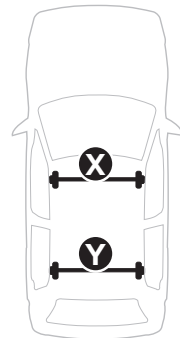
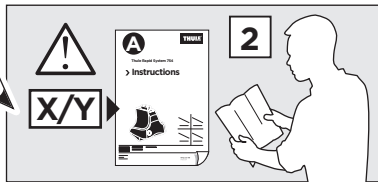
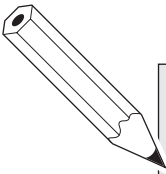

	Y (scale)	Y (mm)	Y (inch)
NISSAN Sentra, 4-dr Sedan, *13-	37,5	1026	40 3/8

2

NISSAN Sentra, 4-dr Sedan, *13-

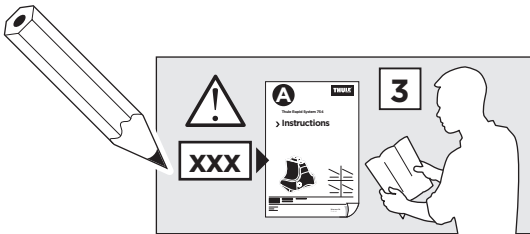
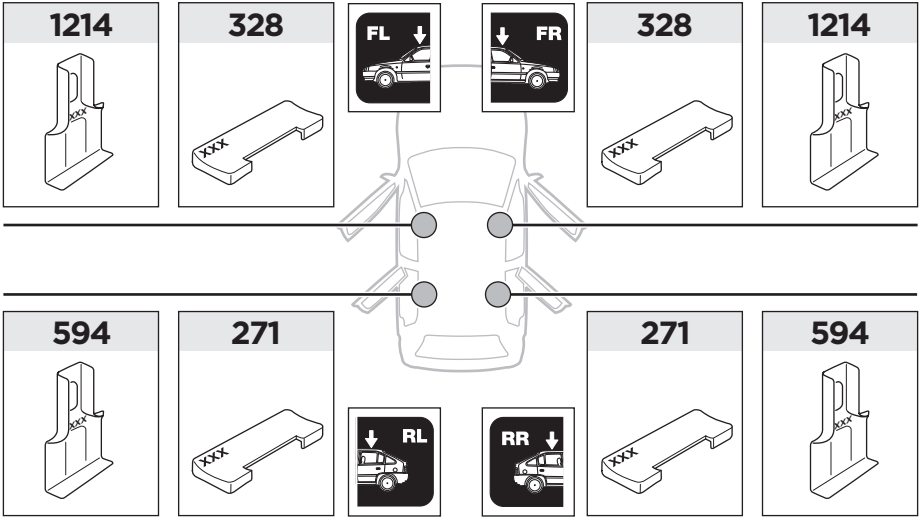

3

	W (mm)	Z (mm)	W (inch)	Z (inch)
NISSAN Sentra, 4-dr Sedan, *13-	305	610	12	24

